



Perfit FS

—
User Manual



Index

1

Product Information

1. Perfit FS	04
2. Key Features	05

2

General Information

1. Technical Data	12
2. Workflow	13

3

Technical Instruction

1. Block Selection	14
2. Minimum Wall Thickness	17
3. Prep Guide	18
4. Positioning Instruction	19
5. Milling Strategy	20
6. Finishing	22
7. Ultrasonic Cleaning	23
8. Sandblasting	23
9. Glazing	24
10. Cementation	24

4

FAQ

26

01. Perfit FS



Perfit FS is the world's first fully sintered zirconia block independently developed by Vatech Laboratory. This innovative product is optimized for one-visit dental restorations. Perfit FS is a material that simultaneously satisfies the processing simplicity of existing chair-side blocks and the high stability of zirconia.

Zirconia powder, the main material of Perfit FS, is a unique composition specially developed at Vatech Laboratory that holds the patent rights. This powder is created through a zirconia powder mixing recipe exclusively for Perfit FS, involving the addition of inorganic materials and a special sintering process.

Even though it is fully sintered zirconia, Perfit FS shows good milling performance and has high crack resistance, providing great satisfaction to everyone by providing efficiency in dental care and stability to patients. These make Perfit FS an innovative solution in the field of one-visit dental restorations and sets new standards in the dental materials market.



02.

Key Features

Excellent Machinability



1) Microstructures

Since fully sintered zirconia is a new form of restoration material, users could have questions about its machinability. Perfit FS's high level of machinability can be proved by comparing it to the microstructure of 5Y-TZP* which has the most similar characteristics to Perfit FS and by comparing it to Glass ceramic.

*5Y-TZP: Zirconia with 5 mol% yttria

Perfit FS vs 5Y-TZP (Sintered)

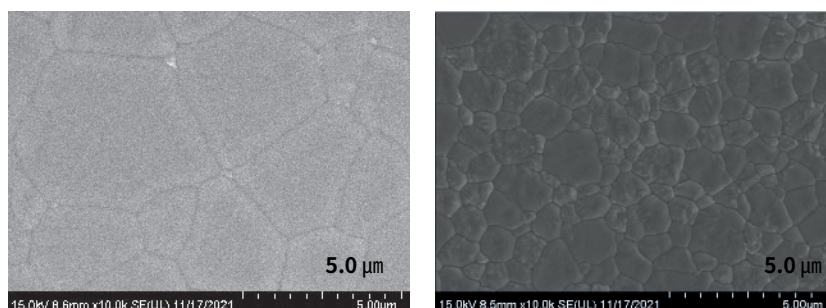

Perfit FS

5Y-TZP

Grain size of Perfit FS is more than 4 times bigger than the 5Y-TZP. The bigger the grain size, the lower the hardness, and it means a 'soft' characteristic of the material. Therefore, when the force is applied to its surface by a grinding tool, it will demonstrate 'soft' grinding. In other words, Perfit FS keeps the advantages of zirconia and raises the machinability level at the same time.

Perfit FS vs Glass Ceramic (Sintered)

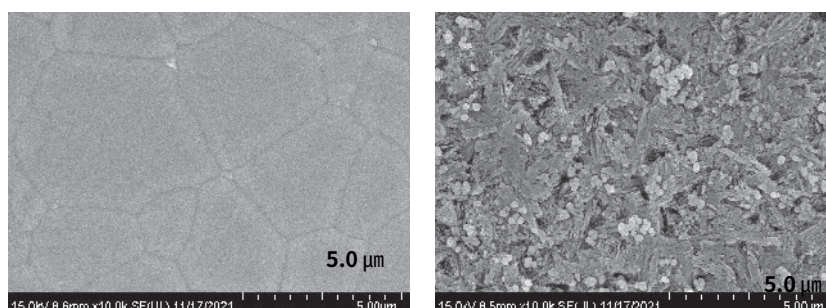

Perfit FS

Glass Ceramic

Compared to the microstructure of Perfit FS and Glass ceramic, the grain shape of Perfit FS is simpler and rounder than that of Glass ceramic. When grinding is performed on Perfit FS, the grains chip off without impacting other grains. On the other hand, the grain shape of Glass ceramic is complex and sharp. This kind of shape easily affects the adjacent grains when they chip off, and it increases the possibility of chipping. From the microstructural characteristics of Perfit FS, suitable and stable milling can be expected with low chipping.

2) Scratch Hardness

From this experiment, 5kg of diamond tip forces to the polished surface of Perfit FS, 5Y-TZP, and Glass ceramic and analyzed the scratch groove and hardness. Since the scratch test has a similar environment to the grinding, the machinability can be assessed based on the scratch groove and figure of scratch hardness.

Perfit FS vs 5Y-TZP (Sintered)

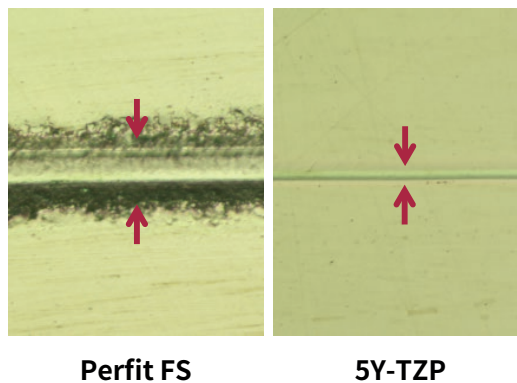

Comparing the groove width of Perfit FS and 5Y-TZP, Perfit FS shows a wider groove than 5Y-TZP. If the same amount of force is applied but it shows a wider area of groove, it means this material can be grinded more easily. The scratch hardness of Perfit FS is about 16.8 GPa, while that of 5Y-TZP is 19.3 GPa, which is lower than Perfit FS. In short, Perfit FS is a fully sintered zirconia, but it has better machinability than normal zirconia discs such as 5Y-TZP in sintered condition.

Perfit FS vs Glass Ceramic (Sintered)

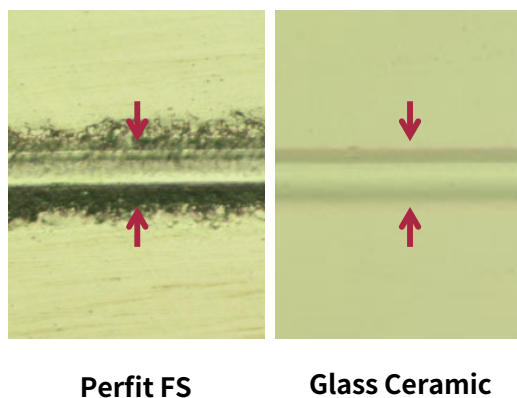

Comparing the scratch groove of Perfit FS and Glass ceramic, in the case of Perfit FS, the diamond tip has been smoothly pushed to both sides of the groove. This type of cracking occurs when micro grains move in a curved form. This aspect means a low possibility of chipping and fracture because there are few short cracks in a straight line. On the other hand, in the case of Glass ceramic, clear straight cracks occurred on both sides of the groove. Since the clear straight cracks are easy to propagate to the surrounding area, there is a high possibility of chipping and fracture. Considering the scratch groove and cracking behavior of Perfit FS, it can be expected that Perfit FS will show excellent machinability in prosthetic processing.

3) Merlon Test

The Merlon test results presented in “ISO/DIS 18675 Dentistry — Machinable ceramic blanks (2020)” also confirm the excellent machinability of Perfit FS compared to existing chair-side blocks.

The Merlon test evaluates machinability using a specimen with four divided vertical walls (Merlon) and a bottom. After machining the walls and bottoms with a different thickness from 0.1 mm to 0.5 mm, the processed specimens were visually inspected for fractures. The results were as follows.

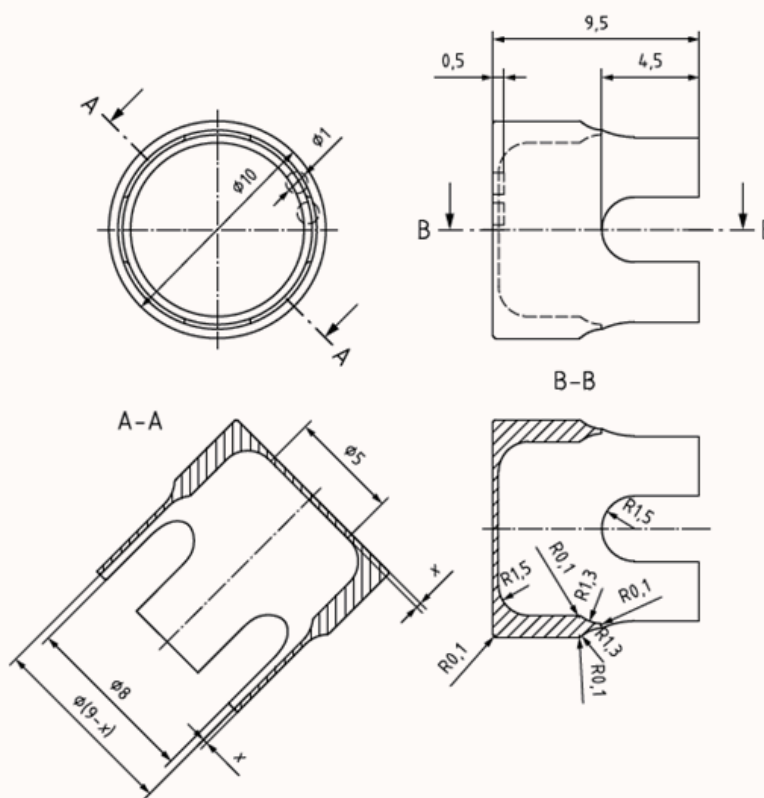

Merlon shape and dimensions according to ISO 18675:2022 for evaluating ceramic machinability

	0.1mm	0.2mm	0.3mm	0.4mm	0.5mm
Fully Sintered Zirconia Perfit FS					
Lithium Disilicate Em**					
Zirconia-Reinforced Lithium Silicate Ce**					
Fully Crystallized Lithium Disilicate Li**					
Lithium Disilicate Based Te**					

According to the experimental results, unlike other companies' chair-side blocks that fractured at walls and bottom when processed from 0.1 mm to 0.3 mm thickness, Perfit FS showed a 100% success rate without fracture from 0.2 mm to 0.5 mm thickness. This result means that Perfit FS has higher crack resistance compared to other companies' chair-side blocks.

When comparing the results of processing at 0.1 mm thickness, we can see that only two walls were broken at Perfit FS, while the remaining walls and the bottoms are not damaged. In contrast, the bottoms of the other chair-side blocks were lost, and it was difficult to find merlons that maintained their shape. These results demonstrate that even thin-walled restorations can be reliably fabricated using Perfit FS.

vatech
Perfit FS™

DENTAL ZIRCONIA
FULLY SINTERED BLOCK



CE 1639

MADE IN KOREA



High Stability

Fracture toughness is the most important value that can prove the clinical stability of restorations. Perfit FS has high fracture toughness, which makes it highly resistant to crack propagation, so the decline of flexural strength is very low when a crack defect occurs. The experimental data that proves this are as follows.

1) Higher crack resistance, lower chipping and fracture probability

After Vickers indentation at 10 kg load

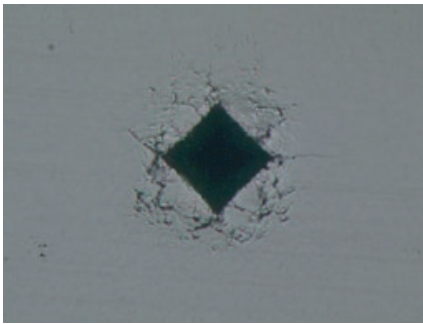

Perfit FS

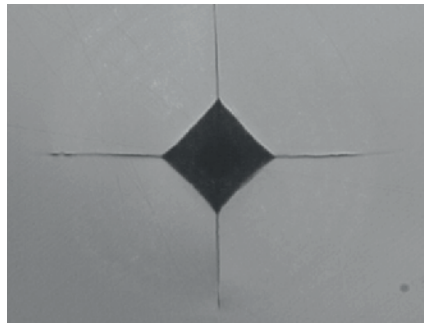

5Y-TZP

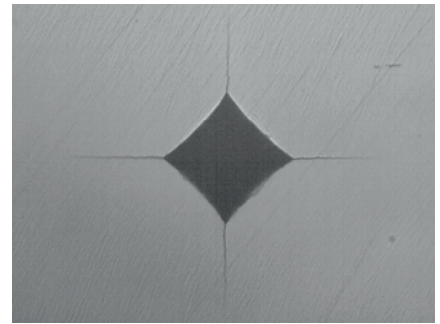

Glass Ceramic

- The above experiment was conducted to measure the indentation crack length of Perfit FS, 5Y-TZP and Glass ceramic products when a 10kg load was applied by Vickers hardness tester.
- When comparing 5Y-TZP and Glass ceramic, Perfit FS only generates lateral cracks, and no radial cracks are visible coming out from the edges of the diamond indentation.
- This indentation behavior means that Perfit FS has high fracture toughness with excellent defect resistance. Therefore, the chipping and fracture probability is very low during grinding and chewing mastication.

2) Higher fracture resistance, lower strength degradation

Comparison Evaluation of Fracture Resistance
- Perfit FS vs Glass Ceramics

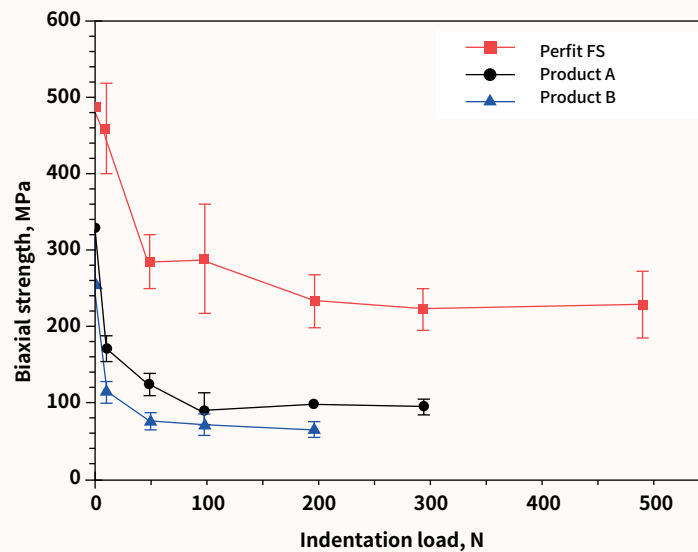

- The above experimental results show the biaxial strength behavior after different indentation load using a Vickers hardness to check that how well the material can withstand external force and fracture.
- When a load of each weight is applied to the material, Perfit FS shows only about 5% degradation of biaxial strength at a 1kg load condition, while products A and B (Glass ceramics) show about 50% degradation. Moreover, products A and B (Glass ceramics) fractured at 30kg and 20kg indentation load is applied, respectively.
- This low strength degradation of Perfit FS resulted from the high fracture resistance compared to other materials. If a defect occurs during grinding and chewing mastication, Perfit FS will be able to withstand it without breaking, but other materials will not.

Fracture toughness is closely related to the durability of the material. The higher the defect resistance of the restorative material, the more resistant the material tends to be to external forces and internal stresses. This means that the material will remain stable for a longer time without defects and will be avoided or, if they do occur, they may diffuse slowly. These properties ensure that Perfit FS can be used stably and long-term in the oral cavity compared to other restorative materials.

01.

Technical Data (Properties)

The chart below shows the technical data of the fully sintered block.
Vatech doesn't provide sintering schedule as Perfit FS does not require sintering.

* Standard Composition

Material	% by weight (Perfit FS)
Zirconium oxide(ZrO ₂)	80.0 - 90.0
Yttrium oxide(Y ₂ O ₃)	10.0 - 15.0
Niobium pentoxide(Nb ₂ O ₅)	5.0 - 10.0
Other oxides	2.0 - 5.0

* Physical Properties

Property	Result Value
Flexural strength (3-point)	500 MPa
Fracture toughness	6.9 MPa · m ^{1/2}
Vickers hardness	8.5 GPa
Coefficient of Thermal Expansion (CTE)	10.6 x 10 ⁻⁶ /K
Modulus of elasticity	202 GPa
Translucency	44 %
Type / Class (ISO 6872)	II / 4

Perfit FS A2 reference property

The sample size

- Flexural strength : 3 x 4 x 45 (mm)
- Translucency : 1.0 mm Thickness

Evaluation Method

- Flexural strength : ISO 6872:2015(E)

Key Source

- Vatech Laboratory(Self-Measurement)

02.

Workflow

Perfit FS is a fully sintered zirconia block, and does not need sintering and firing processes after milling. This is advantageous in creating restorations quickly in comparison with other Chair-side blocks. Please refer to the below workflow.

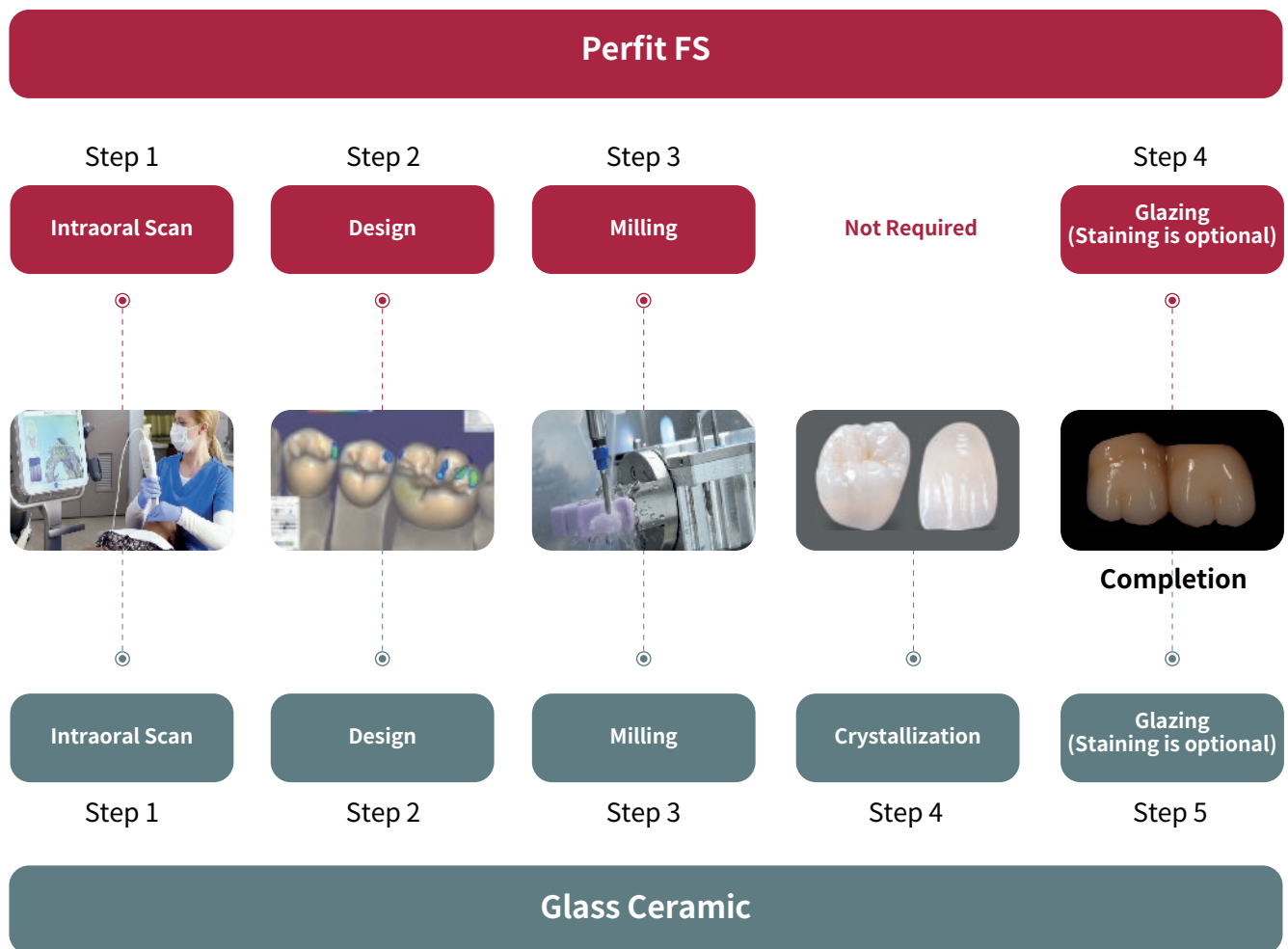

01. Block Selection

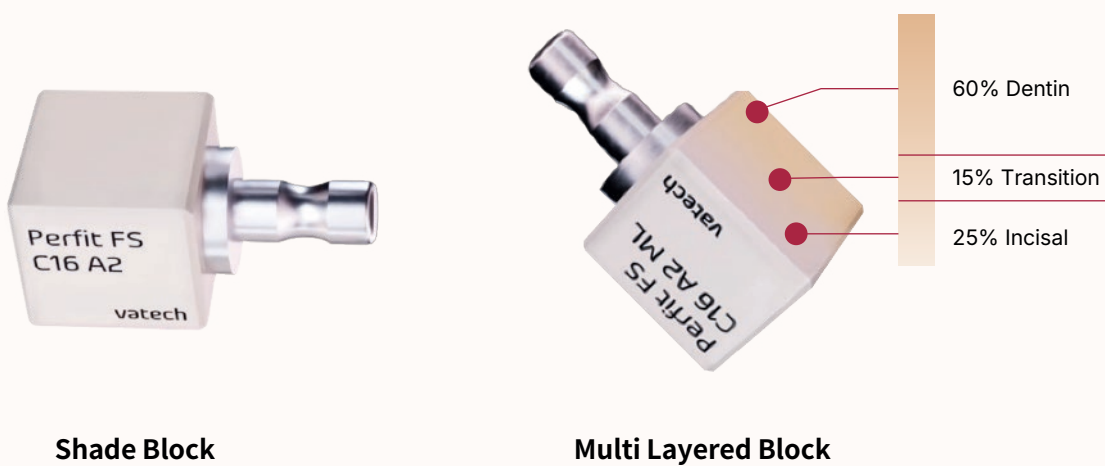

Shade Block

Multi Layered Block

Perfit FS lineup consists of a pre-shaded block and a multi layered block. The users may choose the right types of block by considering its indications and details of the restoration.

Pre-shaded block is categorized into dentin shades. Its indications include inlay/onlay, coping, crown and 3-unit bridge. With matching dentin shade, the pre-shaded block results in ideal restoration outcome.

The multi layered block is used in cases that require detailed shade expression. Indications include crown and 3-unit bridge.





The sizes of I10 and I12 are not provided in a multilayered block, due to nesting difficulty and shade reproduction.





1) Indications for use

Refer to indications for use as below.

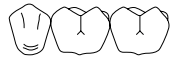
**Perfit FS
(Pre-Shaded Block)**

<p>Perfit FS (I10) Perfit FS (I12)</p>	 <p>Inlay / Onlay</p>
<p>Perfit FS (C14) Perfit FS (C16)</p>	   <p>Single Crown (Anterior) Single Crown (Posterior) Coping</p>
<p>Perfit FS (B32)</p>	 <p>Full Contour Bridge (up to 3 units)</p>

**Perfit FS
(Multilayered Block)**

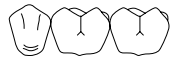
<p>Perfit FS (C14) Perfit FS (C16)</p>	  <p>Single Crown (Anterior) Single Crown (Posterior)</p>
<p>Perfit FS (B32)</p>	 <p>Full Contour Bridge (up to 3 units)</p>

2) Geometry

There are five types of sizes in Perfit FS, and user may select blocks according to the length of the crown. I means Inlay/Onlay, C means Crown, and B means Bridge. Please refer to block sizes below.

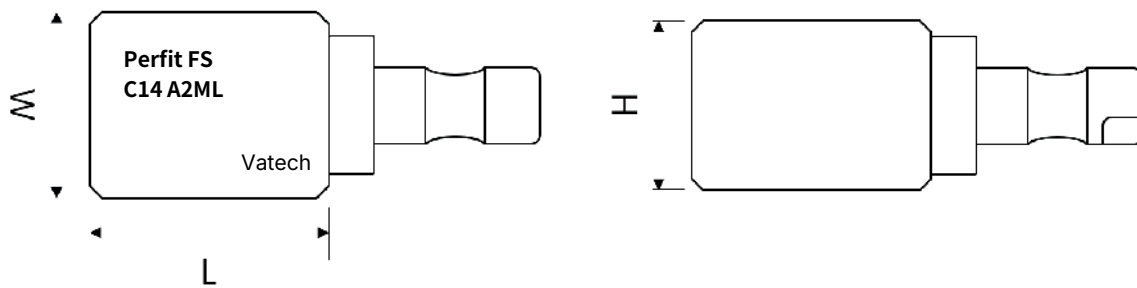

	L(mm)	W(mm)	H(mm)
I 10	15	10	8
I 12	15	12	10.4
C 14	18	14	12.7
C 16	18	15.9	17.8
B 32	32	15.1	15.1



02.

Minimum Wall Thickness

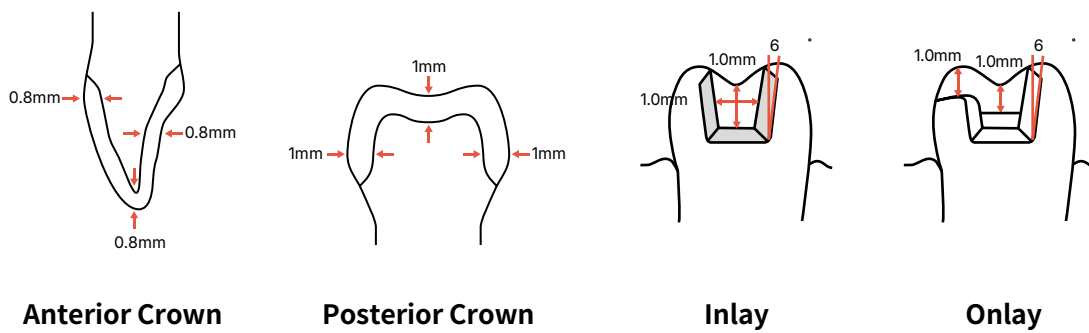

Minimum Wall Thickness is the most important factor to consider to avoid crack in the patient's mouth. The minimum wall thickness is different depending on the indications, so please refer to the picture above and the table below.

In the anterior case, the masticatory force is not strong, so the minimum wall thickness may be relatively thin compared to the posterior case.

For bridge case, the connector dimensions should follow the guide below.

If an abutment shade shows dark stump, the minimum wall thickness should be more than 1 mm.

	Anterior		Posterior	
	Minimum Thickness(mm)	Connector Dimensions(mm ²)	Minimum Thickness(mm)	Connector Dimensions(mm ²)
Inlay/Onlay			1.0	
Crown	0.8		1.0	
3-unit Bridge	1.0	12	1.0	16

03. Prep Guide

To prevent misfit, tooth preparation should be properly executed to integrate the restoration and the abutment surface.

The Tooth Preparation surface should not be angled or sharp.
Chamfer Margin or Shoulder Margin is recommended.
Chamfer Margin has a curve slope and brings unique distribution of stress are suitable.
Shoulder Margin gives sufficient space for restorations production.
Please refer to the minimum wall thickness for tooth preparation.



- Smooth the preparation surface and do not form undercut.
- Complete the angle point with a curved surface; abutment should not be sharp or angled.
- Ensure that the thickness of the dental restoration is uniform.
- Round the line angle to avoid stress.

* Contraindication

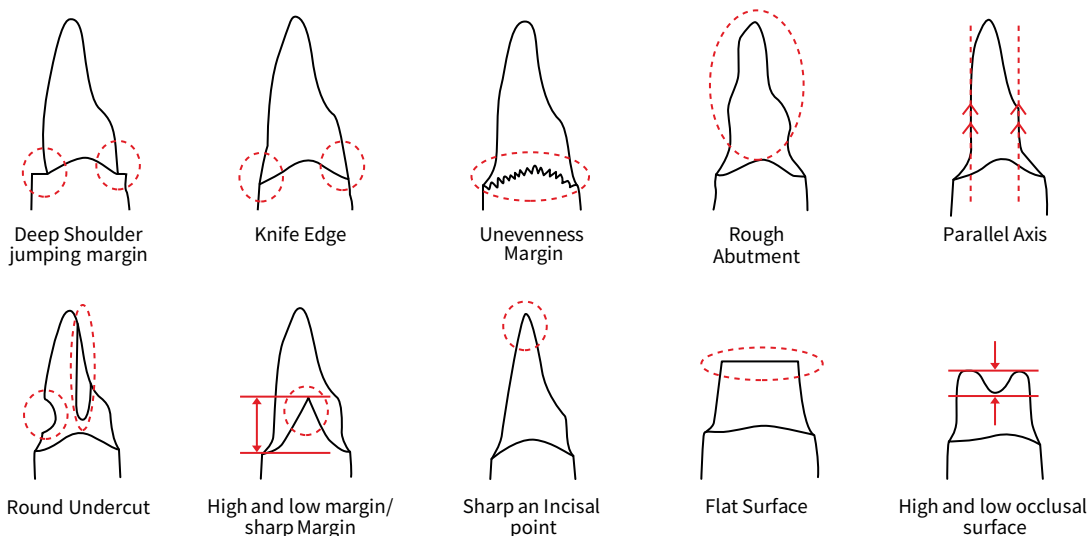

04.

Positioning Instruction

Positioning multilayered zirconia block is important in order to express right shade and translucency using CAM S/W. Optimal translucency and shade are possible if the incisal zone, the intermediate zone, and the body zone are adjusted with the heights of crown and bridges accordingly.

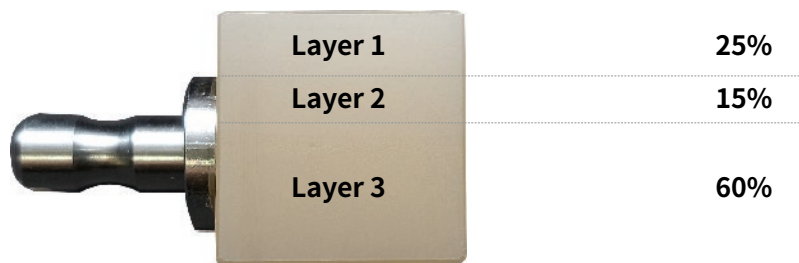

Perfit FS A2

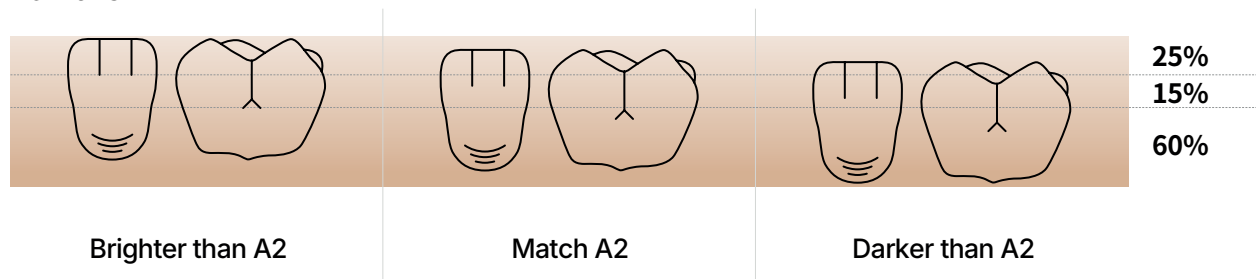

Perfit FS multi layer block consists of a three-layers, Dentin Zone 60%, Intermediate Zone 15%, and Incisal Zone 25%. Refer to the image above for optimal results.

05. Milling Strategy

Refer to the milling strategy below to select a milling machine type that is compatible with Perfit FS. Before using Perfit FS, technical support requires your milling machine to check the milling strategy including the tool and CAM system.

* Milling Information

Processing	Production Method	Axis	Mandrel Type
Grinding	Wet Type	4 or 5	Universal Type (or CEREC mandrel type)

- 4-axis or 5-axis wet type milling machine that can mill glass ceramic blocks.
- A milling machine operating at a spindle speed of >60,000 rpm in wet environment.
- The use of grinding tool (diamond electroplated tool) is mandatory.
- Diamond plated tools are required throughout the restoration processes including milling and finishing.
- We recommend that sprue diameter at crown is $\varnothing 2.5\text{mm}$, sprue diameter at material is $\varnothing 3.5\text{mm}$

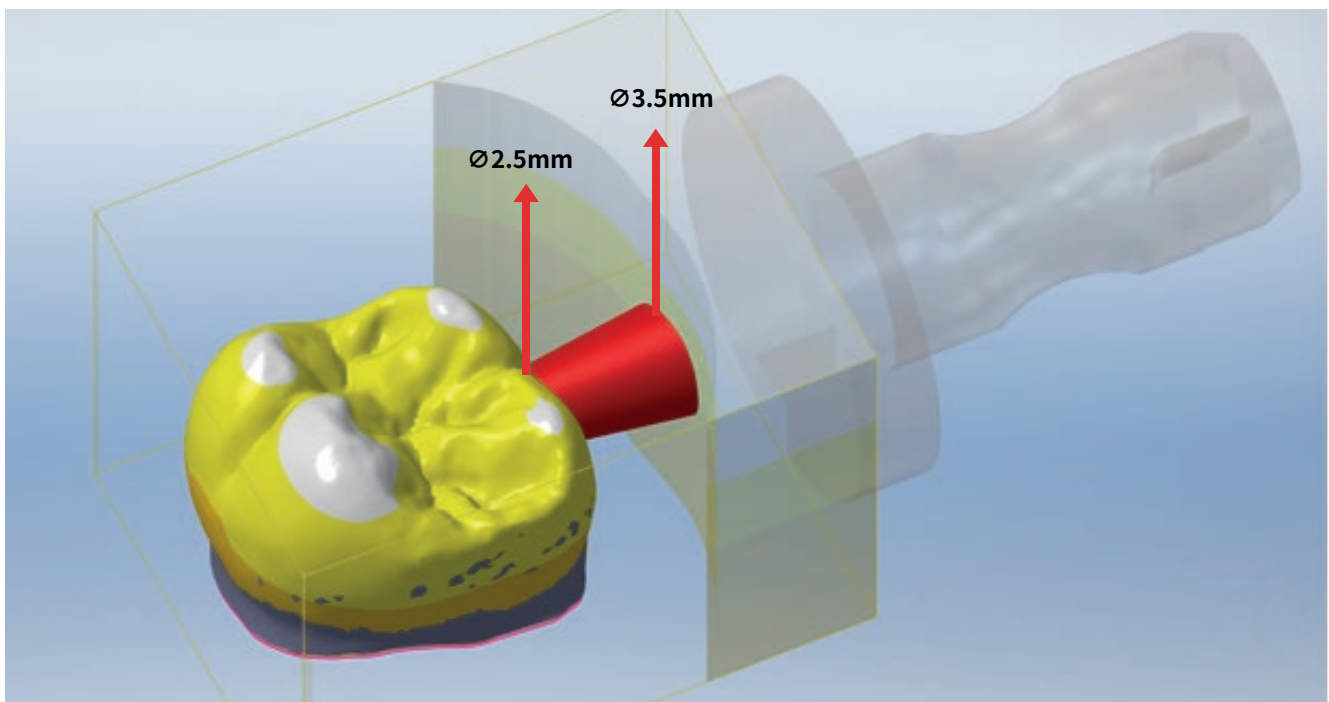

* Material Selection

For material selection in CAM S/W, select IPS e.max CAD.

* Milling Process

1. Attach the block to the machine.
2. Enter the size information of the block.
3. Input the information required for machining.
4. Check the inflow of grinding coolant.
5. Be sure to spray the coolant while the block is processing.
6. Remove the finished block.

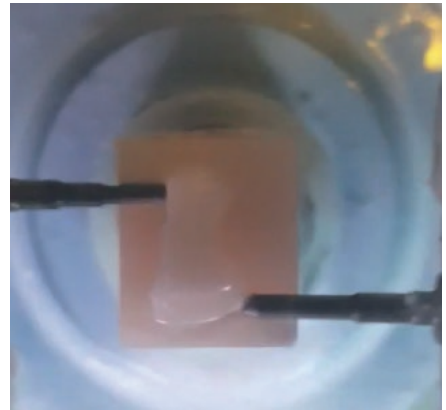
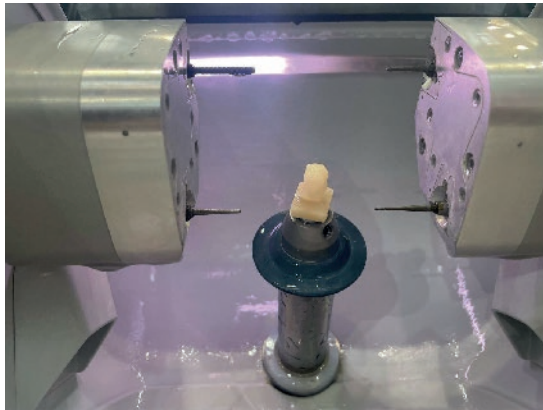

06. Finishing

When separating the sprue, use a disc, wheel, and a carbide point with low speed and low pressure. Utilize a rough bur first; then a soft bur to make the surface more natural. Be careful when handling thin margin.

Separate sprue from the incisal using Diamond disc (heatless product recommended) for zirconia.



Remove sprue with stone wheel for zirconia.



1

2

3



Surface Trim with Silicon Carbide Point for 1st Polishing.



To remove the oil film generated on the surface during milling, Use ultrasonic cleaner for one minute.

07. Ultrasonic Cleaning

In order to remove the oil film on the surface generated during milling, cleaning should be performed using an ultrasonic cleaner. Staining and glazing paste does not adhere well without removing the oil film.



Put Isopropyl alcohol (IPA, 70% alcohol) in a container and soak the restoration to be cleaned. Place container in ultrasonic cleaner and wash for 1 minute



Wash and dry with clean water.

08. Sandblasting (Optional)

Using alumina oxide (Al_2O_3) of 100 μm in particle size, blast at a pressure of 2~4 bar for approximately 15 seconds.

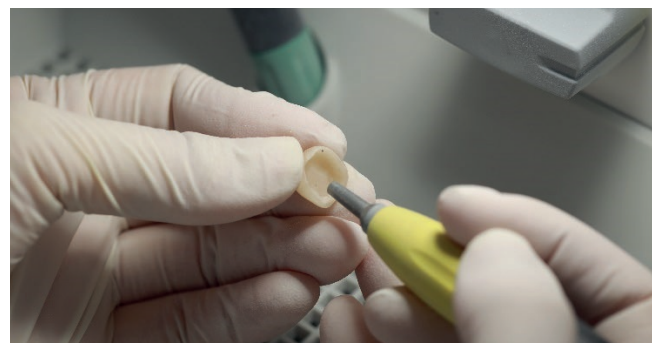
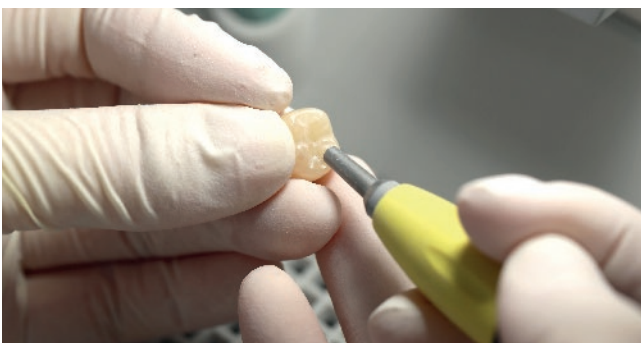

09. Glazing(Staining is optional)

After the sprue separation is completed, glazing is applied on the crown(Staining is optional). Most Staining and Glazing use products are may be used with a thermal expansion coefficient between 9 and 11. Follow the firing temperature of the glazing manufacturer.

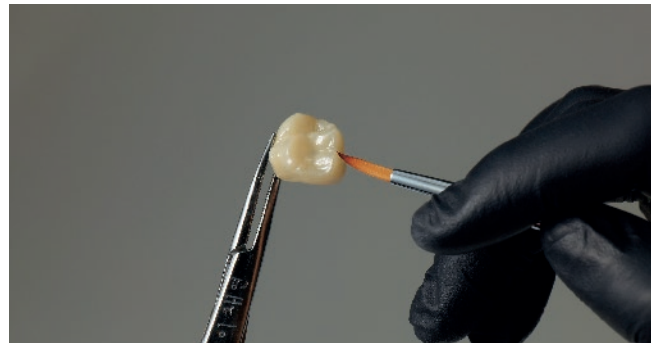
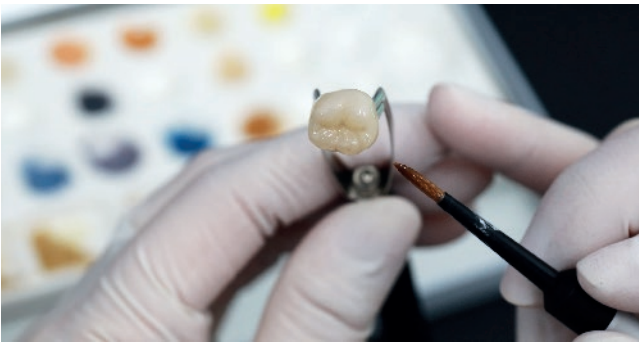

* High polishing is not recommended as it can decrease aesthetic.

10. Cementation

The types of cement recommendation for zirconia restoration are RMGI and self-adhesive resin cement.

- **RMGI(Resin Modified Glass Ionomer) Type :**
Crown & Bridge (not recommended for Inlay/Onlay due to aesthetic)
- **Resin Type :** Inlay/Onlay, Crown & Bridge



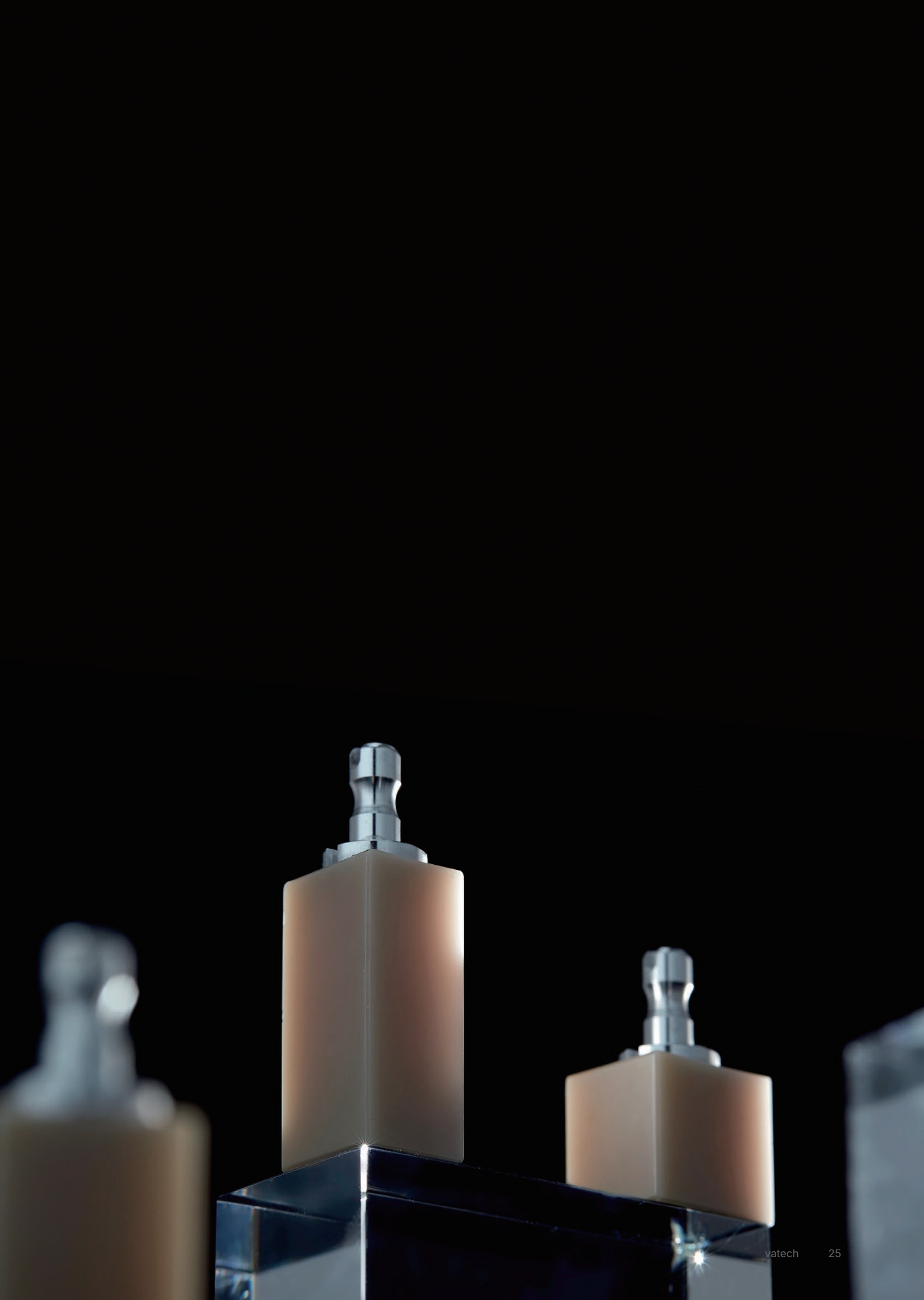

FAQ

Material

1. What is the unique about Perfit FS(fully sintered zirconia)?

The special inorganic material added to Perfit FS zirconia powder dramatically increases machinability by reduction the hardness of the block.

The load test shows scratch grooves formed by indentation load is similar to glass ceramic (partially crystallized) block.

2. Does Perfit FS have multilayered blocks? If so, What is the rate of layers?

Layer 1(25%), Layer 2(15%), Layer 3(60%) from incisal(top) to cervical(bottom).

Milling

1. Which milling machines are compatible?

4-axis or 5-axis wet type milling machines that can mill glass ceramic blocks.

* Before using Perfit FS, technical support requires your milling machine to check the milling strategy including the tool and CAM system.

* Tested Milling Machine

- Perfit OVIS (Robots and Design)
- CEREC MC X, CEREC MC XL, Primemill, inLab MC XL (Dentsply Sirona)
- DWX-42W (Roland DG)
- CORiTEC one, CORiTEC one+, CORiTEC 150i Pro (Imes-icore)
- L-100 (Lilivis)

Finishing

1. Is it possible to build up on the surface of Perfit FS?

Yes, the users may build up on the surface of Perfit FS.

2. Is it possible to apply opaque solution on the surface of Perfit FS?

Applying opaque coloring or paste on fully sintered zirconia is very difficult and deemed infeasible. Although there are opaque powders, it is not recommended.

3. Is it necessary to etch inner surface?

No, etching is not necessary for Perfit FS.

4. What types of a cementation is used?

The recommended cementations for zirconia restoration are RMGI and self-adhesive resin cement.

• RMGI(Resin Modified Glass Ionomer) Type :

Crown & Bridge (not recommended for Inlay/Onlay due to aesthetic)

• Resin Type : Inlay/Onlay, Crown & Bridge

5. Is it possible to polish the surface of Perfit FS?

High gloss polishing is not recommended as it can decrease the strength and aesthetic compared to glazing. High gloss polishing on anterior may be used if necessary.

6. Is it possible to use stains and glaze paste regardless of manufacturers?

Stains and glaze are related to CTE (Coefficient of Thermal Expansion).

The CTE value of Perfit FS is $10.6 \times 10^{-6}/K$.

We recommend any stains & glaze products that are close to the CTE value of Perfit FS.



vatech

38, Saneop-ro 155 beon-gil, Gwonseon-gu, Sunwon-si, Gyeonggi-do, Republic of Korea, 16648

E-mail. sales@vatechmcis.com

Web. www.vatechmcis.com/en